

CAL-VAC® POS-A-SET®

RUPTURE
DISC
ASSEMBLIES

DESIGNED
TO PROTECT
AGAINST
IMPLOSION OR
OVERPRESSURE
CONDITIONS

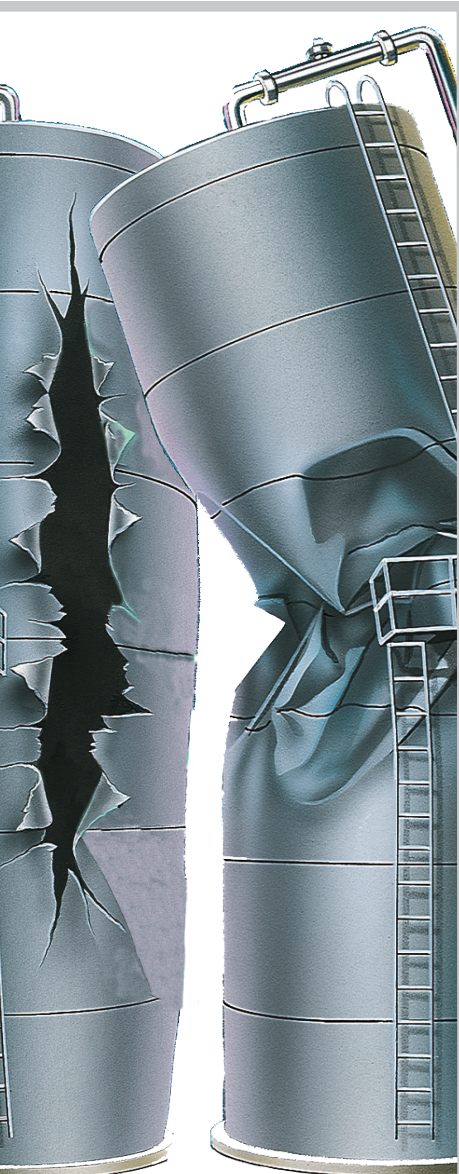

CAL-VAC® and POS-A-SET® Rupture Disc Assemblies are highly accurate, double acting pressure relief devices designed to protect processing and storage tanks against implosion or overpressure conditions that can occur in:

- Positive Pressure // overfill, external fire, steam regulator failure
- Vacuum Relief // liquid pump out, insufficient flow through sanitary vent filter, flash vacuum due to CIP cool rinse, primary vent malfunctions, blanket gas or air regulator failure

Both designs relieve pressure settings starting as low as 1 InWC (inches water column) differential. **The difference in the CAL-VAC Rupture Disc and POS-A-SET Rupture Disc is the orientation of the components to meet the relieving requirements.** The CAL-VAC Rupture Disc relieves ultra low pressure in the vacuum (negative) pressure direction, while the POS-A-SET Rupture Disc relieves ultra low pressure in the positive pressure direction.



BENEFITS

The CAL-VAC® and POS-A-SET® Rupture Disc Assemblies provide many benefits, which include:

- Dual directional (positive and negative) pressure protection to relieve ultra low pressure as low as 1 InWC in one direction and a higher pressure in the other direction
- When specified, can be manufactured to meet 3A Sanitary Standards when a Sanitary Fitting Holder is utilized
- No moving parts eliminates the possibility of mechanical malfunction and assures proper operation
- Available with either an Insert or Sanitary Fitting Holder
- Provides lower maintenance cost and greater reliability compared to a valve, which increases productivity of your system

Rupture Disc Specifications

CAL-VAC



Sanitary Style

Insert Style

POS-A-SET



Sanitary Style

Insert Style

CAL-VAC® and POS-A-SET Rupture Discs are highly accurate pressure relief devices for protecting vessels and equipment against damaging pressure conditions.

DETAILS

Sizes:

3" - 12" (80mm - 300mm)

Available Maximum Temperature Limit:

See [Recommended Temperature Limits](#) section & [Table 3](#)

Service:

Gas or Liquid

Nonfragmenting Design:

Yes

Operating Conditions:

Static, Cyclic or Pulsating

Top Section and Ring Material(s):

316 SS, 316L SS, Alloy C276, Nickel, Alloy 400, Alloy 600 & Tantalum

Girdle Material(s):

Fluoropolymer, 316 SS, 316L SS & Alloy C276

Seal and Slot Cover Material:

Fluoropolymer

Seat Configuration:

Flat Seat (FS), Sanitary Fitting (SF)

Holders:

CAL-VAC & POS-A-SET Sanitary Holder, CAL-VAC & POS-A-SET Insert Holder

Compatible with the Following Alarm System:

Integral B.D.I.®

Tagging:

Insert Style: Three dimensional stainless steel flow direction tag attached

Sanitary Style: Unattached stainless steel tag provided

Burst Pressures:

See [Table 1](#) and [Table 2](#)

Manufacturing Range:

See [Table 1a](#)

Maximum Recommended Operating Ratio:

See [Table 1a](#) and [Table 2](#)

FEATURES

Ultra Low Pressure Relief Controlled By a Girdle

As a pressure in the system approaches the burst pressure setting, the girdle becomes loaded until it deflects back past a knifeblade assembly located in the holder. As the girdle passes the knifeblade assembly, the seal is penetrated and cut in a triangular pattern to relieve the ultra low pressure. Refer to [Table 2](#) for available girdle settings and maximum recommended operating pressures.

Higher Pressure Relief Controlled By a Top Section

The perforated metal top section, under tension loading, relieves pressure in the opposite direction than the girdle when overpressure in the system occurs. It incorporates CDC's seven hole pattern at the apex of the rupture disc dome. The seven-hole pattern, along with six pre-cut sections, provides a non-fragmenting design. Refer to [Table 1](#) for minimum and maximum burst ratings of the CAL-VAC and POS-A-SET Rupture Disc top section.

Additionally the top section's pre-punched holes provide optimum flow through the rupture disc when relieving in the ultra low pressure direction through the girdle.

Reduce Product Build-Up and Promote Easier Cleaning

CAL-VAC and POS-A-SET Rupture Discs have a flat seat design to reduce susceptibility to product buildup and promote easier cleaning.

Rupture Disc Components

1 PERFORATED METAL TOP SECTION... provides higher pressure relief or support as required.

OR

2 RING...provides seat protection for the seal when used in place of a top section for applications which do not require pressure relief or support.

SLOT COVER (not shown)...positioned between the seal and top section seal to protect the fluoropolymer seal from the perforated metal top section.

3 FLUOROPOLYMER SEAL...distributes pressure uniformly in both the positive and negative (vacuum) directions and eliminates external or internal leakage. An optional B.D.I.® Alarm Strip is applied to the fluoropolymer seal when the rupture disc is to be incorporated in an alarm system.

4 GIRDLE...controls ultra low pressure relief.

CAL-VAC and POS-A-SET Rupture Disc components are supplied to the user

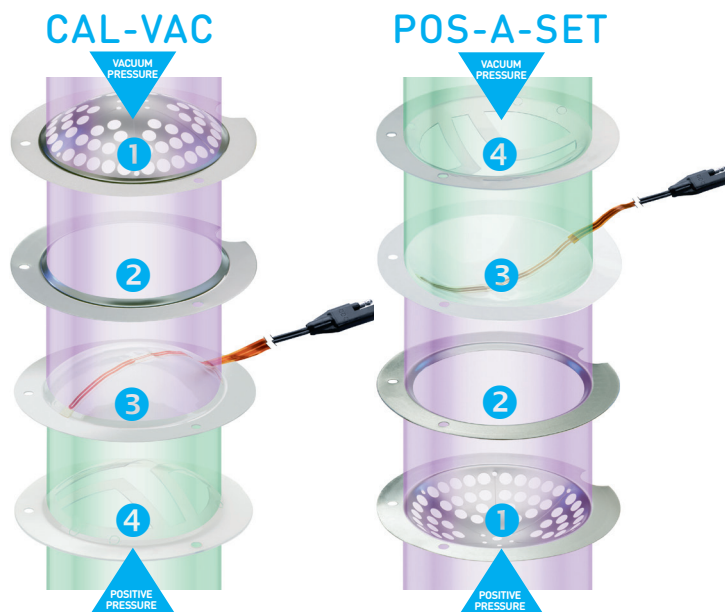

without permanent attachment. Upon pressure relief through the girdle, when a fluoropolymer girdle is used, the fluoropolymer seal (and B.D.I.® Alarm Strip, if included) is usually the only component which needs to be replaced. Upon pressure relief through a metal girdle, the girdle, fluoropolymer seal (and B.D.I.® Alarm Strip, if included) must be replaced. If pressure relief occurs through the top section, then the entire rupture disc must be replaced.

Rupture Disc Specifications

Manufacturing Range/Burst Tolerance of Top Section

Manufacturing Range is defined as the allowable pressure range within which a rupture disc is rated. It is based upon the customer requested rated burst pressure. The manufacturing range for the CAL-VAC and POS-A-SET Rupture Disc top section varies depending upon the burst rating.

After the top section has been manufactured and tested, it is marked with the rated burst pressure based on the performance of the produced product.

Table 1a and 1b reviews Manufacturing Range and Burst Tolerance of the CAL-VAC and POS-A-SET Rupture Disc top section. Reduced Manufacturing Ranges are available upon request.

MIN/MAX Girdle Rating

The CAL-VAC and POS-A-SET Rupture Disc girdle has MIN/MAX rating which is the pressure range in which the product opens and relieves pressure. For available MIN/MAX Ranges, see Table 2 for details.

For example: In the vacuum direction, a 6" CAL-VAC Rupture Disc with a MAX relief pressure of 13 InWC, will have a MIN pressure of 7 InWC.

Recommended Temperature Limits

The CAL-VAC and POS-A-SET Rupture Disc can operate in temperature conditions of -40°F to 400°F (-40°C to 204°C) depending upon the type of material chosen for the rupture disc girdle component. Table 3 shows the temperature limitations for various rupture disc girdle materials.

Sizing

Sizing for all configurations of the CAL-VAC and POS-A-SET Rupture Disc must be provided by the factory. Data required for a sizing evaluation include: flow requirement in positive and vacuum pressure direction, flow media in each direction, burst rating in each direction and rated temperature.

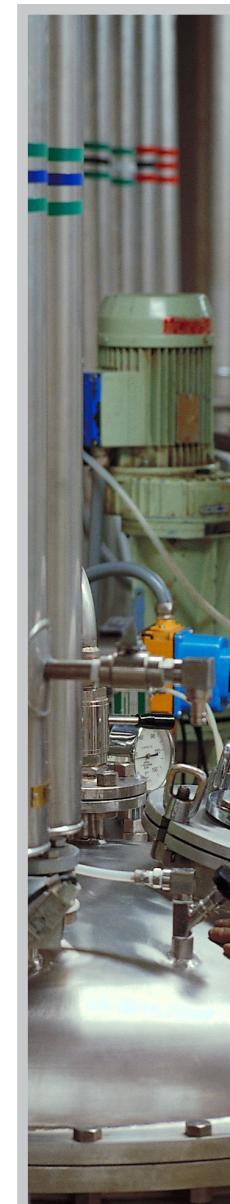
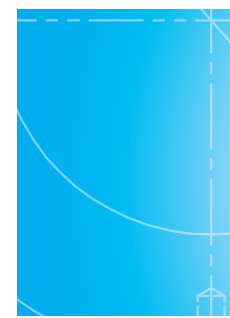

CAL-VAC/POS-A-SET Tables

TABLE 1 // Rupture Disc Top Section // Minimum/Maximum Burst Rating at 72°F (22°C)

CAL-VAC Positive Direction and POS-A-SET Vacuum (Negative) Direction

Nominal Size	Burst Pressure		
	MINIMUM	MAXIMUM	
		Insert Type Holder	Sanitary Fitting Type Holder
psig / barg	psig / barg	psig / barg	
3 in / 80mm	8 / 0,552	150 / 10,3	100 / 6,89
4 in / 100mm	7 / 0,483	125 / 8,62	75 / 5,17
6 in / 150mm	4 / 0,276	100 / 6,89	50 / 3,45
8 in / 200mm	3 / 0,207	75 / 5,17	40 / 2,76
10 in / 250mm	3 / 0,207	50 / 3,45	30 / 2,07
12 in / 300mm	2 / 0,138	40 / 2,76	N/A

TABLE 1a // Manufacturing Ranges for Top Section

CAL-VAC Positive Direction and POS-A-SET Vacuum (Negative) Direction

Requested Rated Burst Pressure	Standard Manufacturing Range
above 100 above 6,89	-4% / +7%
above 50 up to and including 100 psig above 3,45 up to and including 6,89 barg	-4% / +10%
above 19 up to and including 50 psig above 1,31 up to and including 3,45 barg	-4% / +14%
above 12 up to and including 19 psig above 0,827 up to and including 1,31 barg	-10% / +20%
above 8 up to and including 12 psig above 0,552 up to and including 0,827 barg	-30% / +30%
up to and including 8 psig above 0,345 up to and including 0,552 barg	-40% / +40%

TABLE 1b // Burst Tolerances and Maximum Recommended Operating Pressures for Top Section

CAL-VAC Positive Direction and POS-A-SET Vacuum (Negative) Direction

Rated (Marked) Burst Pressure	Burst Tolerance Around Rated (Marked) Burst Pressure	Maximum Recommended Operating Pressure
above 40 psig above 2,76 barg	-5% / +5%	80% of Rated (Marked) Burst Pressure
above 14 up to and including 40 psig above 0,965 up to and including 2,76 barg	-2 psig / + 2 psig -0,138 barg / + 0,138 barg	
above 12 up to and including 14 psig above 0,827 up to and including 0,965 barg	-10% / +10%	
above 8 up to and including 12 psig above 0,552 up to and including 0,827 barg	-15% / +15%	
up to and including 8 psig up to and including 0,552 barg	-20% / +20%	

TABLE 2 // Rupture Disc Girdle // Start Relief (minimum)/Full Relief (maximum) Burst Rating at 72°F (22°C)

CAL-VAC Vacuum (Negative) Direction and POS-A-SET Positive Direction

Nominal Size	MAX Rating (Full Relief Point) InWC		MIN Rating (Start Relief Point) InWC		Maximum Recommended Operating Pressure
	Fluoropolymer Girdle		316 SS, 316L SS & Alloy C276 Girdle		
	min	max	min	max	
3 in / 80mm	7	36	12	115	For MAX ratings up to & including 45 InWC: MAX Rating minus 6 InWC For MIN ratings up to & including 10 InWC: MIN Rating minus 1 InWC
4 in / 100mm	7	36	12	70	
6 in / 150mm	7	36	12	70	For MAX ratings above 45 InWC: MAX Rating minus 15 InWC For MIN ratings above 10 InWC: 90% of MIN Rating
8 in / 200mm	7	36	12	70	
10 in / 250mm	N/A	N/A	12	60	
12 in / 300mm	N/A	N/A	12	60	

TABLE 3 // Rupture Disc // Recommended Temperature Limits

Girdle Material	Temperature Limit		Girdle Material	Temperature Limit	
	Minimum	Maximum		Minimum	Maximum
Fluoropolymer	40°F (-40°C)	150°F (66°C)	316 SS, 316L SS and Alloy C276	40°F (-40°C)	400°F (204°C)

B.D.I.® Alarm System for Use with CAL-VAC/POS-A-SET

When immediate notification of pressure or vacuum relief is required, Continental Disc Corporation's B.D.I. (Burst Disc Indicator) Alarm System should be used. Designed for use with any Continental CAL-VAC or POS-A-SET Rupture Disc, the B.D.I. Alarm automatically notifies an operator, through audio and/or visual warnings, WHEN and WHERE a rupture disc has relieved positive or vacuum overpressure. This enables the operator to promptly respond to an abnormal process condition or to improper equipment operation or inadequate cleaning.



The heart of the B.D.I. system is the alarm strip which is attached to the fluoropolymer seal. When used with the CAL-VAC or POS-A-SET Rupture Disc, the B.D.I. Alarm System provides dual warning within one rupture disc.

When vacuum occurs, the CAL-VAC knifeblade assembly (located in the holder inlet) severs the fluoropolymer B.D.I. Alarm Strip, disrupting the electrical current through the alarm strip and initiating a signal to the control panel or other warning devices. If positive overpressure relief occurs, the alarm strip breaks when the perforated metal top section bursts.

In the POS-A-SET design, the knife blade assembly (located in the holder outlet) severs the fluoropolymer B.D.I. Alarm Strip when positive overpressure occurs. If vacuum occurs, the alarm strip breaks when the perforated metal top section bursts.

The B.D.I. Alarm is resistant to most corrosives and can operate at temperatures ranging from -40°F to 400°F [-40°C to 204°C].

MTB-700 ALARM MONITOR



The MTB-700 Alarm Monitor incorporates intrinsically safe galvanically isolated barriers, approved for use in many countries worldwide. An MTL5018AC barrier is utilized on the MTB-700 Alarm Monitor with a 120/240 VAC input power option. An MTL5018 barrier is utilized on the MTB-700 Alarm Monitor with the 24 VDC input power option. Upon disc rupture, these barriers activate signals and/or output relays to warn operators and actuate pumps, valves or other equipment connected to the system.



FOR MORE INFORMATION ON OUR OTHER BURST DISC INDICATION PRODUCTS, PLEASE SEE THE [B.D.I.® BURST DISC INDICATOR DATASHEET](#).

CAL-VAC/POS-A-SET Holders

CAL-VAC/POS-A-SET Insert Holders

The CAL-VAC and POS-A-SET Insert Holder is designed for installation between ASME, JIS or DIN class flanges as shown in [Table 4](#). It is available in 3" through 12" (80 – 300mm). Locator pins on the holder inlet assure proper rupture disc alignment. A knifeblade assembly with PRECISION-HONED EDGES is permanently affixed in the holder inlet for the CAL-VAC, and in the holder outlet for the POS-A-SET to provide pressure relief. Prior to installation, the rupture disc and holder parts are pre-assembled using stainless steel pre-assembly clips.

CAL-VAC/POS-A-SET Sanitary Fitting Holders

The CAL-VAC and POS-A-SET Sanitary Fitting Holder utilizes quick disconnect clamping that provides a secure, leak-tight joint, free of pockets or crevices and permits fast installation, minimizing downtime. A Knifeblade Assembly with PRECISION-HONED EDGES is located in the holder inlet for the CAL-VAC, and in the holder outlet for the POS-A-SET, to provide pressure relief.

CAL-VAC and POS-A-SET Sanitary Fitting Holders are ideally suited for a wide range of applications where contamination and corrosion are hazards. When specified, the Sanitary Fitting Holder can be manufactured to meet 3A Sanitary Standards.

CAL-VAC and POS-A-SET Sanitary Fitting Holders are available in sizes 3" through 10" (80 – 250mm) and require a clamp one size larger than the nominal rupture disc size. Two locator pins assure proper rupture disc alignment. See [Table 5](#) for holder dimensions and corresponding clamp size.

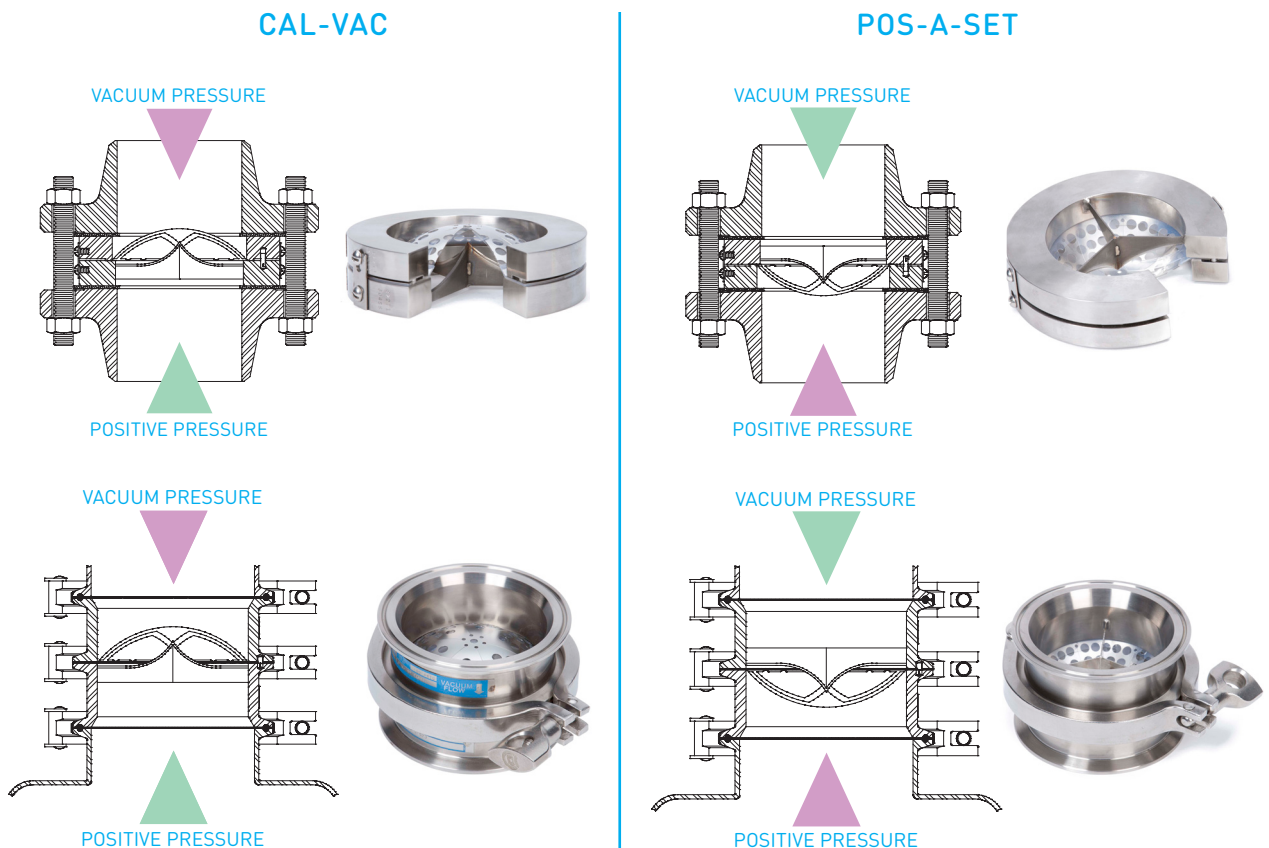

CAL-VAC/POS-A-SET Holders

CAL-VAC and POS-A-SET Insert Holders

CAL-VAC and POS-A-SET Insert Holders are machined from standard materials including carbon steel, 304 SS, 316 SS and Alloy C276. Standard knifeblade materials include heat-treated 17-7 PH stainless steel, 316 SS or Alloy C276. Consult the factory for availability of other holder or knifeblade materials. Weights and dimensions for this holder are shown in [Table 4](#).

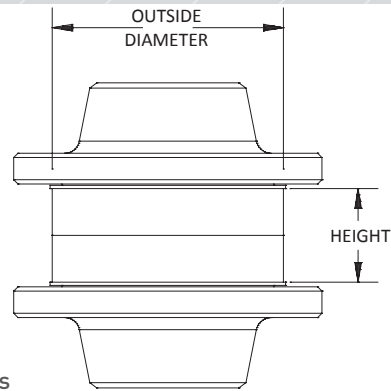

TABLE 4 // CAL-VAC/POS-A-SET Insert Holders // Weights & Dimensions

NOMINAL SIZE	MAXIMUM PRESSURE RATING AT 72°F (22°C) psig/barg	ASME		DIN		JIS		HOLDER Height (inch/mm)	HOLDER Weight (lb/kg)
		Class	Outside Diameter (inch/mm)	Class	Outside Diameter (inch/mm)	Class	Outside Diameter (inch/mm)		
3 in / 80 mm	150 / 10,4					10	5.16 / 131,0	1.25 / 32	4.2 / 1,9
		150	5.25 / 133,4					1.25 / 32	4.5 / 2,0
				10/40	142,0	16 / 20	5.39 / 137,0	1.25 / 32	4.9 / 2,2
4 in / 100 mm	125 / 8,6					10	6.14 / 156,0	1.25 / 32	5.1 / 2,3
				10 / 16	6.38 / 162,0	16 / 20	6.38 / 162,0	1.25 / 32	5.9 / 2,7
		150	6.75 / 171,5					1.25 / 32	7.3 / 3,3
6 in / 150 mm	100 / 6,9			10 / 16	8.54 / 217,0	10	6.14 / 156,0	1.25 / 32	5.1 / 2,5
						16 / 20	9.25 / 235,0	1.25 / 32	5.9 / 2,7
		150	8.63 / 219,2					1.25 / 32	7.3 / 3,3
8 in / 200 mm	75 / 5,2			10/16	10.71 / 272,0			1.25 / 32	11 / 5,0
						16 / 20	11.02 / 280,0	1.25 / 32	14 / 6,4
		150	10.88 / 276,4					1.25 / 32	13 / 5,9
10 in / 250 mm	50 / 3,5			10 / 16	12.87 / 327,0			1.5 / 38	20 / 9,1
						10	12.99 / 330,0	1.5 / 38	20 / 9,1
		150	13.25 / 336,6			16 / 20	13.9 / 353,0	1.5 / 38	28 / 13
12 in / 300 mm	40 / 2,8			10	14.87 / 377,0	10	14.76 / 375,0	1.5 / 38	21 / 9,5
				16	15.08 / 383,0			1.5 / 38	27 / 12
		150	16 / 406,4			16 / 20	15.87 / 403,0	1.5 / 38	33 / 15

Contact your sales representative for availability of other flange classes.

CAL-VAC and POS-A-SET Sanitary Fitting Holders

CAL-VAC and POS-A-SET Sanitary Fitting Holders are machined from standard materials of 316 or 316L SS. Standard knifeblade material is 316 SS. Weights and dimensions for this holder are shown in [Table 5](#).

TABLE 5 // CAL-VAC/POS-A-SET Sanitary Fitting Holders // Weights & Dimensions

Nominal Size	MAXIMUM PRESSURE RATING AT 72°F (22°C) psig/barg	Outside Diameter (inch/mm)	Height (inch/mm)	Clamp Connection Size (inch/mm)	Weight (lb/kg)
3 in / 80mm	100 / 6,89	4.68 / 118,9	3 / 76	4 in / 100mm	4.4 / 2,0
4 in / 100mm	75 / 5,17	6.57 / 166,9	4 / 102	6 in / 150mm	15 / 6,8
6 in / 150mm	50 / 3,45	8.57 / 217,7	4 / 102	8 in / 200mm	18 / 8,2
8 in / 200mm	40 / 2,76	10.57 / 268,5	4.5 / 114	10 in / 250mm	24 / 11
10 in / 250mm	80 / 2,07	12.57 / 319,3	4.5 / 114	12 in / 300mm	29 / 13

Contact your sales representative for availability of other holder or knifeblade materials.

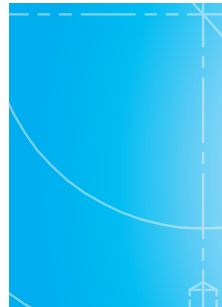
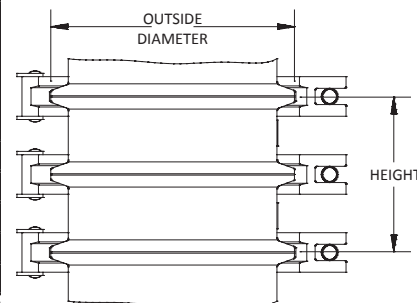



China Manufacture License

Equipment, Industries & Applications

Below you will find common equipment, industries and applications that utilize CAL-VAC and POS-A-SET Rupture Discs. If you don't see your application listed, just contact us and let us show you how we have handled pressure problems just like yours.

Equipment	Market Type	Industry	Applications
Silo Type Storage Tanks & Vertical or Horizontal Processing Vessels	Sanitary	Pharmaceutical Bio-Tech Cosmetics Nutritionals Animal Health	Storage of USP Purified Water for Production, Formulation & CIP Solutions
		Beverage Production	Fermentation, Packaging, Storage & Aging Vessels
		Dairy Products	Aseptic Storage & Processing Vessels
		Food or Juice Processing or Storage	Storage & Processing of Food Grade Products
		Semiconductor Plants	Ultra-Pure Water for Microchip Manufacturing
Glove Boxes	Sanitary	Pharmaceutical Bio-Tech Laboratories	Positive Pressure Protection for Gloves & Hatches
Thin Wall Process or Storage Vessels	Industrial	Oil & Gas	Condensate Storage
		Bio-Fuels Bio-Processing	Positive & Vacuum Protection of Low Pressure Vessels or Equipment
		Chemical Processing & Storage	
FRP Vessels	Industrial & Municipal	Chemical Processing & Storage	Low Pressure Positive & Vacuum Protection for Fiberglass Storage Tanks

NOTE: Product parameters are based on United States customary units. Values in metric units are provided for reference only.

 	<p>HEADQUARTERS // 3160 W. Heartland Drive Liberty, MO 64068 USA Ph [816] 792 1500 Fax [816] 792 2277 sales@contdisc.com</p>	<p>contdisc.com</p>
<p>THE NETHERLANDS Energieweg 20 2382 NJ Zoeterwoude-Rijndijk The Netherlands Ph +(31) 71 5412221 Fax +(31) 71 5414361 cdcnl@contdisc.com</p>	<p>CHINA Room 1312, Tower B, COFCO Plaza No. 8 JianGuoMenNei Avenue Beijing (10005), P.R. China Ph +(86) 10 522 4885 Fax +(86) 10 6522 2885 cdcchina@contdisc.com</p>	<p>INDIA 423/P/11, Mahagujarat Industrial Estate, Moraiya, Sarkhej-Bavla Road, Ahmedabad (GJ) 382213 INDIA Ph +(91) 2717 619 333 Fax +(91) 2717 619 345 gcmpl@contdisc.com</p>