



ASME Code Symbol Stamp
Available When Specified



Pressure Equipment Directive
Available When Specified



HPX PRODUCT FAMILY // SANITARY SOLUTIONS

SANITRX HPX & SANITRX HPX II RUPTURE DISCS

SANITRX HPX & SANITRX HPX II Rupture Discs are semicircular scored reverse acting rupture discs designed specifically for the pharmaceutical, biotech, food and beverage industries. These rupture discs are available to fit between industry standard sanitary ferrules, NA-CONNECT® flanges or SANITRX fittings.

SANITRX HPX & SANITRX HPX II Rupture Discs are shipped in sanitary, environmentally friendly, non-toxic packaging.

Applications

The SANITRX HPX & SANITRX HPX II Rupture Discs can be used in a wide range of sanitary and hygienic applications throughout pharmaceutical, biotech, food, and beverage facilities. The following list is only a small sample of the many ways in which this outstanding rupture disc can be used:

AUTOCLAVES

BIOREACTORS

CLEAN STEAM PIPING

PROCESS VESSELS

HEAT EXCHANGERS

FILTERS

STORAGE & TRANSPORT VESSELS

MIXING, DRYING, GRANULATING EQUIPMENT

WFI VESSELS & PIPING

LYOPHILIZERS (FREEZE DRYING)

CIP & SIP SKIDS AND PIPING

FERMENTERS





Features

- To optimize service life and rupture disc performance, Continental Disc Corporation manufactures and tests each SANITRX HPX and SANITRX HPX II Rupture Disc order for compressible or incompressible relief conditions as required by your application. SANITRX HPX and SANITRX HPX II Rupture Discs manufactured and tested only for compressible (gas/vapor) relief conditions may not function properly in an incompressible (liquid) application. Please state in your specifications and orders if a scenario exists for relief of incompressible media or if relief conditions exist only for compressible media.
- Ideal for liquid or gas/vapor applications.
- The SANITRX HPX is also available with a horizontal tag option.



- Optional fluoropolymer coating is available for corrosion protection on the process and/or vent side of the rupture disc.
- Electropolished surface finishes are available as an option.
- ASME Code Section VIII, Division 1 compliant. National Board Certified K_R flow resistance values:
 - K_{RG} (gas) = 1.13 and K_{RL} (liquid) = 1.60 for **SANITRX HPX**
 - K_{RG} (gas) = 1.60 and K_{RL} (liquid) = 1.88 for **SANITRX HPX II**
- For rating, range and tolerance information, please see pages 6-7.

SANITRX HPX BURST PRESSURES //

The following table shows burst pressures available at 72°F (22°C)

SIZE	316 SS / 316L SS		HASTELLOY® C	
	MINIMUM	MAXIMUM	MINIMUM	MAXIMUM
	psig / barg	psig / barg	psig / barg	psig / barg
1"	25	250	30	250
25 mm	1,72	17,2	2,07	17,2
1½"	10	200	20	200
40 mm	0,689	13,8	1,38	13,8
2"	10	150	15	150
50 mm	0,689	10,3	1,03	10,3
3"	10	100	15	100
80 mm	0,689	6,89	1,03	6,89

Minimum and Maximum pressures are based upon the corresponding minimum and maximum of the manufacturing range at 72°F (22°C).

SANITRX HPX II BURST PRESSURES //

The following table shows burst pressures available at 72°F (22°C)

SIZE	316 SS / 316L SS		HASTELLOY® C	
	MINIMUM	MAXIMUM	MINIMUM	MAXIMUM
	psig / barg	psig / barg	psig / barg	psig / barg
1½"	200	500	200	500
40 mm	13,8	34,5	13,8	34,5
2"	150	450	150	450
50 mm	10,3	31,0	10,3	31,0
3"	100	175	100	175
80 mm	6,89	12,1	6,89	12,1
4"	10	100	10	100
100 mm	0,689	6,89	0,689	6,89

Minimum and Maximum pressures are based upon the corresponding minimum and maximum of the manufacturing range at 72°F (22°C).



FOR EVEN LOWER PRESSURES, SEE THE [SANITRX LPX DATASHEET](#)

GASKETS

Standard gaskets are designed for use in industry standard ferrules, SANITRX flat face fittings and NovAseptic NA-CONNECT® Flanges. Replacement slotted gaskets are available upon request. Slotted gaskets of the same material and seat type as the original should be used to maintain the original specifications as shown on the rupture disc tag.

Gasket materials shown in the Gasket Materials and Temperatures table (see below) have been tested and are compliant with USP Class VI, Section <88> Biological Reactivity Tests, “In Vivo”. PTFE fluoropolymer gaskets are compliant with FDA CFR Title 21, 177.1550. Materials other than PTFE fluoropolymer and steel reinforced PTFE fluoropolymer shown in the Gasket Materials and Temperatures table are compliant with FDA CFR Title 21, 177.2600. All of these gaskets are free of animal and human derivatives, polishing compounds and release agents.

GASKET MATERIALS & TEMPERATURES //

The following gasket materials are readily available. *Other materials available upon request.*

GASKET MATERIALS	FDA COMPLIANT	USP CLASS VI COMPLIANT	SERVICE TEMPERATURES				RECOMMENDED FOR USE WITH:		
			MINIMUM		MAXIMUM		SANITARY FITTING CLAMP	MBC® CLAMP	NA-CONNECT® HOLDER
			°F	°C	°F	°C			
Peroxide Cured Silicone	✓	✓	-80	-62	450	232	✓	✓	✓
Platinum Cured Silicone	✓	✓	-80	-62	350	177	✓	✓	✓
White VITON®	✓	✓	-20	-29	400	204	✓	✓	✓
Black VITON®	✓	✓	-20	-29	400	204	✓	✓	✓
White EPDM	✓	✓	-55	-48	275	135	✓	✓	✓
Black EPDM	✓	✓	-55	-48	300	149	✓	✓	✓
PTFE Fluoropolymer	✓	✓	-40	-40	450	232		✓	✓
Steel Reinforced PTFE Fluoropolymer	✓	✓	-20	-29	450	232		✓	

REPLACEMENT GASKETS

Sanitary slotted replacement gaskets are available for flat face SANITRX (SF) and industry standard (IS) seat types. When replacing gaskets, care must be taken when removing the original gasket, installing the replacement gasket and use of a gasket of the same material and seat type.



SANITARY ACCESSORIES // GASKETS

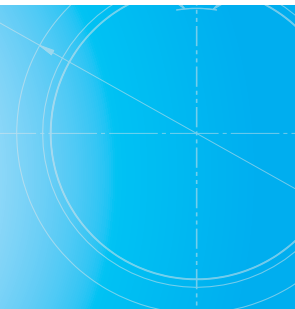

FITTINGS

Continental Disc Corporation offers ASME BPE and 3A compliant grooved fittings designed for use with the SANITRX HPX Rupture Disc product family.

SANITARY ACCESSORIES // FITTINGS

SPOOL PIECE

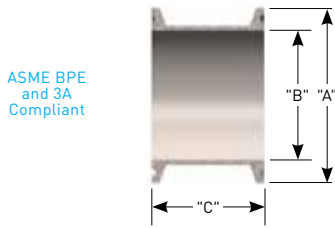

BUTT WELD FERRULE

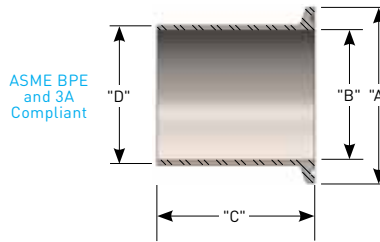

NOMINAL SIZE	DIMENSIONS			WEIGHT	PART NUMBER
	"A" in mm	"B" in mm	"C" in mm	lb kg	
1" 25 mm	1.98	0.85	1.63	0.41	433480050
	50,3	21,6	41,4	0,19	
1 1/2" 40 mm	1.98	1.36	1.63	0.24	433560050
	50,3	34,5	41,4	0,11	
2" 50 mm	2.52	1.86	1.63	0.33	433600050
	64,0	47,2	41,4	0,15	
3" 80 mm	3.58	2.86	2.25	0.64	433620050
	90,9	72,6	57,2	0,29	
4" 100 mm	4.68	3.81	2.25	1.09	433700050
	119	96,8	57,2	0,49	

NOMINAL SIZE	DIMENSIONS				WEIGHT	PART NUMBER
	"A" in mm	"B" in mm	"C" in mm	"D" in mm	lb kg	
1" 25 mm	1.98	0.87	1.75	1.00	0.23	434480050
	50,3	22,1	44,5	25,4	0,10	
1 1/2" 40 mm	1.98	1.37	1.75	1.50	0.21	434560050
	50,3	34,8	44,5	38,1	0,095	
2" 50 mm	2.52	1.87	2.25	2.00	0.34	434600050
	64,0	47,5	57,2	50,8	0,15	
3" 80 mm	3.58	2.87	2.25	3.00	0.53	434620050
	90,9	72,9	57,2	76,2	0,24	
4" 100 mm	4.68	3.83	2.25	4.00	0.90	434700050
	119	97,3	57,2	102	0,41	

CONCENTRIC REDUCER

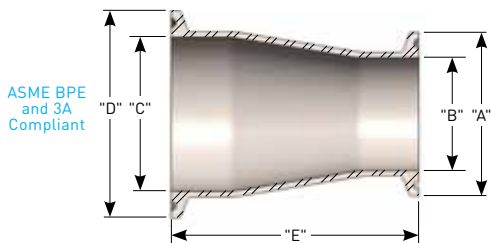

SPOOL PIECE WITH GAUGE TAP

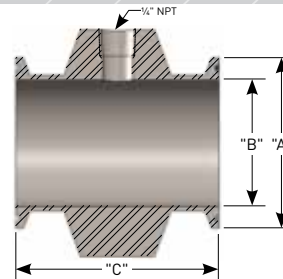

NOMINAL SIZE	DIMENSIONS					WEIGHT	PART NUMBER
	"A" in mm	"B" in mm	"C" in mm	"D" in mm	"E" in mm	lb kg	
1 1/2" x 1" 40 mm x 25 mm	1.98	0.86	1.36	1.98	3.00	0.40	435560050
	50,3	21,8	34,5	50,3	76,2	0,18	
2" x 1 1/2" 50 mm x 40 mm	1.98	1.36	1.86	2.52	3.00	0.45	435600050
	50,3	34,5	47,2	64,0	76,2	0,20	
3" x 2" 80 mm x 50 mm	2.52	1.86	2.86	3.58	5.00	1.00	435620050
	64,0	47,2	72,6	90,9	127	0,45	
4" x 3" 100 mm x 80 mm	3.58	2.86	3.81	4.68	5.13	1.69	435700050
	90,9	72,6	96,8	119	130	0,77	

NOMINAL SIZE	DIMENSIONS			WEIGHT	PART NUMBER
	"A" in mm	"B" in mm	"C" in mm	lb kg	
1" 25 mm	1.98	0.86	3.00	2.84	436483250
	50,3	21,8	76,2	1,29	
1 1/2" 40 mm	1.98	1.36	3.00	2.01	436563250
	50,3	34,5	76,2	0,91	
2" 50 mm	2.51	1.86	3.00	2.54	436603250
	63,8	47,2	76,2	1,15	
3" 80 mm	3.58	2.86	3.00	3.59	436623250
	90,9	72,6	76,2	1,63	
4" 100 mm	4.68	3.81	3.00	4.87	436703250
	119	96,8	76,2	2,21	

NOTE: When using concentric reducers, assure restriction of flow through the reducer is taken into consideration.

NA-CONNECT® FLANGES

Sanitary rupture discs also specifically fits within the sanitary clamping design of the NovAseptic NA-CONNECT® flanges. This flush-mount holder is becoming increasingly popular in sanitary processing industries because it allows installation of the rupture disc directly against the wall of the vessel to allow for easy cleaning and sterilization.



SANITRX HPX II in NA-CONNECT® FLANGES

CLAMPS

The SANITRX HPX Rupture Disc product family is designed for installation directly between sanitary tube O.D. connections secured in place with a heavy-duty clamp, such as the Continental Disc MBC™ (Multi-Bolt Clamp) or a Sanitary Fitting Clamp.

MBC™ Multi-Bolt Clamp

The MBC is a highly durable sanitary clamping device for securing vessel and piping connections in pharmaceutical, biotech, food, beverage, fine chemical, and other sanitary type environments. The multi-bolt clamp design features four stainless steel bolts and nuts securing a two-piece, cast stainless steel body. This sturdy clamp yields the ultimate in connection integrity, providing a dependable, sure-hold for system fittings and components. An opposed multi-bolt pattern, utilizing four bolts, ensures reliable performance and safeguards your system and personnel from possible damage that could result from the failure and release of a clamp relying on only one or two fasteners. The clamp permits installation of the SANITRX HPX Rupture Disc product family, which feature the innovative, attached 3-dimensional flow tag extending beyond the assembly for easy identification of proper rupture disc orientation.

FEATURES

- Solid, cast stainless steel body with multi-bolt pattern for durability and performance under higher pressures and temperatures.
- Bolts, nuts, and lock washers of corrosion resistant 304 SS construction.
- Available in 1" through 4" sizes
- Depending upon size and limitations of complementary components, the clamp can be installed on systems operating at pressures up to 1500 psig (103 barg) or at temperatures up to 450°F (232°C).

MBC SPECIFICATIONS

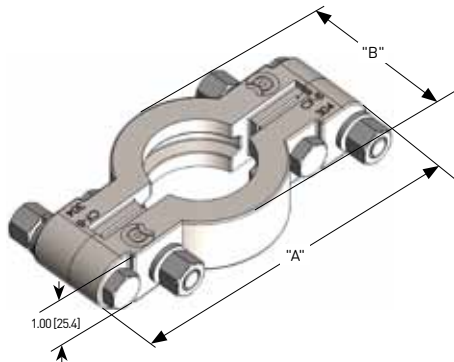

NOMINAL SIZE	DIMENSIONS		WEIGHT lbs kg	CLAMP MAXIMUM OPERATING PRESSURE		PART NUMBER
	"A" in mm	"B" in mm		@ 70°F psig barg	@ 450°F psig barg	
*1½"	5.61	2.71	2.0	1500	500	568560051
40 mm	142	68,8	0,91	103	34,5	
2"	6.11	3.25	2.4	1000	450	568600051
50 mm	155	82,6	1,09	68,9	31,0	568620051
3"	7.12	4.34	3.1	1000	450	
80 mm	181	110	1,41	68,9	31,0	568700051
4"	8.11	5.45	3.4	1000	450	
100 mm	206	138	1,54	68,9	31,0	

* Use 1 ½" [40mm] clamp for 1" [25mm] connection

MBC clamps, in the size noted, are usable at pressures and temperatures below the appropriate curve

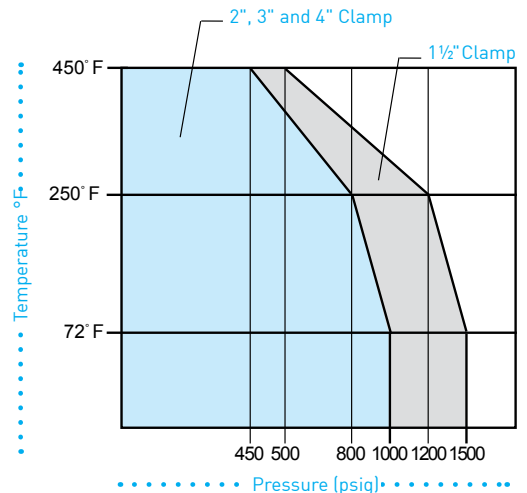

WARNING: The MBC™ tables and charts represent the maximum pressure and temperature ratings. Standard sanitary gaskets and fittings may not be designed to withstand the maximum pressure and temperature stated. **It is the responsibility of the user to verify the maximum pressure and temperature rating of the gaskets, fittings and rupture discs.**

SANITARY
ACCESSORIES //
MBC™ Clamps

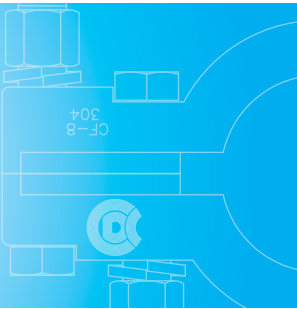

MBC™ CLAMP

SANITARY FITTING CLAMP SPECIFICATIONS

Clamps are quick-release, easy to change and allow space for the tag extension to pass through the clamp adjacent to the hinge.



NOMINAL SIZE	WEIGHT		CLAMP MAXIMUM		PART NUMBER
	lbs kg	@ 70°F psig barg	@ 250°F psig barg		
*1½" 40 mm	0.62	500	300		013560051
	0,28	34,5	20,7		
2" 50 mm	0.73	450	300		013600051
	0,33	31,0	20,7		
3" 80 mm	1.0	350	195		013620051
	0,45	24,1	13,4		
4" 100 mm	1.1	300	150		013700051
	0,50	20,7	10,3		

* Use 1 ½" (40mm) clamp for 1" (25mm) connection

ASME BPE STANDARD

This standard provides requirements applicable to the design of equipment used in the biotech, pharmaceutical and personal care industries including aspects related to sterility and cleanability, materials of construction, dimensions and tolerances, surface finish, material joining and seals.

The standard applies to components in contact with the product, raw materials or intermediates. Systems that are a critical part of the manufacturing process such as water for injection (WFI), clean steam, filtration and intermediate storage may also abide by this standard.

The SANITRX HPX Rupture Disc product family is in compliance with the essential criteria of the ASME BPE standard as follows:

- CIP and SIP cleanable
- Withstands temperatures of 130°C where steam sterilization is required
- The standard surface finish meets SF1 (20 Ra microinch) for the SANITRX HPX Rupture Disc product family & the internal surfaces of the ASME BPE compliant sanitary fittings
- The SANITRX HPX Rupture Disc product family gaskets in the **Gasket Materials and Temperatures** table (see page 18) meet ASME BPE requirements, including full traceability and prohibition of animal derivatives
- Rupture discs and fittings are usually, as a standard, made out of 316L SS material; alternates are available if specified by users
- Fully traceable materials
- Fittings are marked and packaged in accordance with ASME BPE
- USP Class VI certified gaskets meet all ASME BPE requirements including full traceability and prohibition of animal derivatives

SANITARY PACKAGING

The SANITRX HPX product family of rupture discs are shipped in sanitary, non-toxic environmentally-friendly packaging. Benefits include:

- Plastic packaging eliminates direct contact of the rupture disc with open cell material, such as cardboard or foam, which can carry contaminants or leave particles on the rupture disc.
- Clear packaging provides visibility of the rupture disc tag allowing verification of the rupture disc specification without removal from the package.
- The plastic package and cardboard carton are recyclable materials.
- Combined with the vertical tag, the new plastic packaging provides a compact, space saving container for the rupture disc.

RELATED PRODUCTS //

INDUSTRIAL & SANITARY

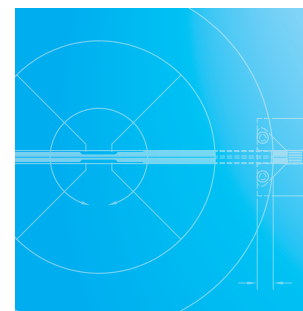

SANITARY FITTINGS,
CLAMP &
RUPTURE DISC

ALARM MONITORS

RELATED
PRODUCTS //
INDUSTRIAL &
SANITARY



BDI-FLX® BURST DISC SENSOR SYSTEM



B.D.I.® ALARM SYSTEM

Continental Disc Corporation provides two systems for monitoring the burst of a rupture disc, the BDI-FLX® Burst Disc Sensor System and the B.D.I.® Alarm System. Common features include:

- Detects venting, provides instantaneous notification of the bursting of a rupture disc.
- Signals emergency equipment, control room and/or operating personnel to alter or stop a process.
- Can be combined with a CDC Alarm Monitor to protect equipment, lives and the environment.

The **BDI-FLX® Burst Disc Sensor System** provides many benefits, which include:

- Allows direct interface to PLC's, DCS (Distributed Control System), alarm monitors or isolating barriers and can provide dry contacts for industrial controls.
- Improved durability:
 - The conductive element is fully encapsulated in corrosive resistant polyimide film
 - The advanced technologies of the sensor strip minimize the risk of damage due to excessive stress beyond recommended bolting load
 - The alignment ring provides a rigid support for the new sensor cable, minimizing cable strain
- Modernized output cable connectors in accordance with IEC 61076-2-101. IP67 rated M12 connector.

➔ *FOR MORE INFORMATION ON OUR BDI-FLX® BURST DISC SENSOR SYSTEM, PLEASE SEE THE: [BDI-FLX® BURST DISC SENSOR SYSTEM DATASHEET](#)*

The **B.D.I.® Alarm System** provides many benefits, which include:

- Expanded availability in sizes up to 36" (900mm)
- Available as integral design to many rupture disc and vent panel products

➔ *FOR MORE INFORMATION ON OUR B.D.I. ALARM SYSTEM, PLEASE SEE THE: [B.D.I.® ALARM SYSTEM DATASHEET](#)*

ENVIRO GUARD® Pipe End Cover

Provide protection of piping, rupture discs, and safety relief valves from unwanted foreign material, rain, insects and/or birds by specifying and installing a ENVIRO GUARD pipe end cover. The ENVIRO GUARD pipe end cover is fabricated from a tough PTFE coated/impregnated fiberglass material suitable for use in harsh environments and temperatures up to 500°F (260°C).

➔ *FOR MORE INFORMATION ON OUR ENVIRO GUARD PIPE END COVER, PLEASE SEE THE: [ENVIRO GUARD PIPE END COVERS DATASHEET](#)*

HPX® RUPTURE DISCS + PRESSURE RELIEF VALVES

ASME ACCEPTED

ISOLATION FROM LEAKAGE

Pressure Relief Valves (PRV) can be a significant source of media leakage and emissions. Due to continually tightening government emission standards, small leaks can be more than troublesome...they can be expensive. By isolating the inlet of a PRV with an HPX® Rupture Disc, a positive seal is established to minimize leakage and reduce fugitive emissions that can escape through the valve seat.

ISOLATION FROM CORROSION

Depending upon the corrosive nature of an application's process media, maintaining equipment for long-term service can be expensive due to the costs of exotic materials for PRV components or frequent changeouts caused by equipment deterioration. Isolating a PRV with an HPX® Rupture Disc minimizes corrosive effects by preventing continual contact between the PRV's wetted parts and the system media.

ADVANTAGES

- When in use, HPX® Rupture Discs provide a superior process seal reducing fugitive emissions
- PRV's reclose after an overpressure event, saving process media and allowing operation to continue until the HPX® Rupture Disc can be replaced
- The HPX® Rupture Disc is available in a variety of materials, including 316SS, Alloy 400, Alloy C276 and Tantalum, which allows for the use of less expensive valve materials

A COMPARISON OF OPTIONS

HPX® Rupture Disc available
in sizes 1"-12" (25mm-300mm)

	PRESSURE RELIEF VALVE	RUPTURE DISC	PRESSURE RELIEF VALVE + RUPTURE DISC
BUBBLE TIGHT*	No	Yes	Yes
COST	High	Low	Medium
MAINTENANCE	High	Low	Medium
ADJUSTABLE	Yes	Fixed Setting	Yes
RECLOSABLE	Yes	No	Yes
REUSABLE	Yes	No	Valve is Reusable Rupture Disc Is Not

*Bubble-Tight (No air bubbles detected with leak detection fluid) Metal-to-Metal Seal

PRESSURE RELIEF VALVE MODEL	ASME CERTIFIED COMBINATION CAPACITY FACTOR (FOR AIR, GAS & STEAM SERVICE)	MINIMUM SIZE
Anderson Greenwood Crosby JOS-E, JBS-E, JOS-H-E	1.000	1" 25 mm
Broady Flow Control 3500	0.999	1" 25 mm
Consolidated Dresser 1900D-2, 1900-30D-2	0.998	1" 25 mm
Consolidated Dresser 1900E-2, 1900-30E-2	0.995	1" 25 mm
Consolidated Dresser ¹ 1900, 1900-30, 1900-35	1.000	1-1/2" 40 mm
Farris 2600, 2600S	0.993	1" 25 mm
LESER 526	1.000	1" 25 mm

Minimum burst pressure: 15 psig (1.03 barg)

ASME certified CCF values apply to all rupture disc materials

1"-8" HPX holders can be directly coupled with a pressure relief valve. HPX-RH and HPX-PT-RH are not designed to be directly coupled with a pressure relief valve. The 10" (250 mm) and 12" (300 mm) HPX holders require a spool piece when used under a pressure relief valve. *[For more details, see the HPX® Rupture Disc Installation Instructions on www.contdisc.com]*



FOR MORE
INFORMATION,
PLEASE SEE THE:
**RUPTURE DISCS +
PRESSURE RELIEF
VALVES Brochure**



Continental Disc[®] Corporation

P E R F O R M A N C E U N D E R P R E S S U R E [®]

NOTE: Product parameters are based on United States customary units. Values in metric are provided for reference only.



**Continental Disc[®]
Corporation**



**GROTH[®]
CORPORATION**
a Continental Disc company

HEADQUARTERS //

3160 W. Heartland Drive
Liberty, MO 64068 USA
Ph (816) 792 1500 | Fax (816) 792 2277
sales@contdisc.com

contdisc.com

THE NETHERLANDS

Energieweg 20
2382 NJ Zoeterwoude-Rijndijk
The Netherlands
Ph +(31) 71 5412221 | Fax +(31) 71 5414361
cdcnl@contdisc.com

CHINA

Room 1312, Tower B, COFCO Plaza
No. 8 JianGuoMenNei Avenue
Beijing (10005), P.R. China
Ph +(86) 10 522 4885 | Fax +(86) 10 6522 2885
cdcchina@contdisc.com

INDIA

423/P/11, Mahagujarat Industrial Estate, Moraiya,
Sarkhej-Bavla Road, Ahmedabad (GJ)
382213 INDIA
Ph +(91) 2717 619 333 | Fax +(91) 2717 619 345
gcempl@contdisc.com